

DATA SHEET

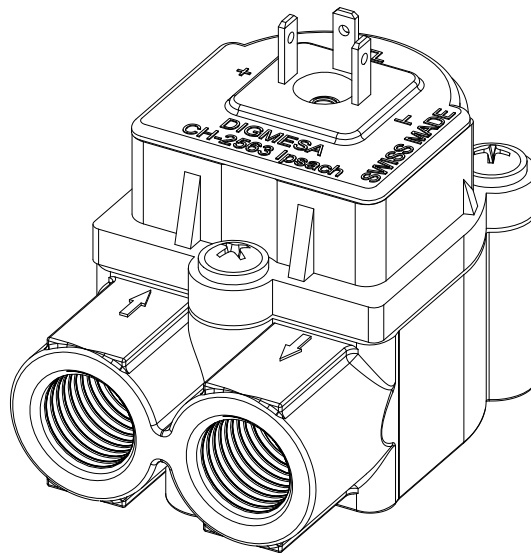

DIGIMESA⁺
CHOOSE THE ORIGINAL

FHK PVDF Chemie
Part number: 937-13xx/Cx01x

Digimesa AG, Keltenstrasse 31, CH-2563 Ipsach / Switzerland
Phone +41 (32) 332 77 77, Fax +41 (32) 332 77 88

www.digimesa.com

Version 02 FHK PVDF Chemie SW19 937-13xx/Cx01x GB Page 1-13

General Description

The FHK Flowmeter is a general-purpose device; its working range can be individually defined according to its nozzle size. It is employed for measuring, regulating or metering and guarantees most precise measurement of fluid quantities. In addition, a pulse generator integrated into the flowmeter guarantees a practically unlimited useful life.

Specific applications: Able to withstand high temperatures, good resistance to chemicals. Compact design, great working range, depending on the nozzle diameter. **Employed in the semiconductor (wafer polishing) sector due to the high purity of materials used.**

Approvals / Standards

EN55014-1:00+A1:01+A2:02, EN61000-6-3:01+A11:04, IEC61000-6-3:06(ed.2.0), EN61000-3-2:06, IEC61000-3-2:05(ed.3.0), EN61000-3-3:95+A1:01+A2:05, IEC61000-3-3:94+A1:01+A2:05(Cons.ed 1.2), EN55014-2:97+A1:01, EN61000-6-1:01, IEC61000-6-1:05(ed.2)



Material:

Housing:	PVDF
Bearing pin:	PCTFE
Nozzle:	PTFE
O-ring:	FPM (Viton) EPDM / Kalrez on request
Turbine:	PVDF 2 Magnets 4 Magnets on request
Magnets	Ceramic Sr Fe O (not in contact with the medium)
Screw:	Inox A2 PT-screw (Phillips cross recessed)

Technical data:

Flow rate:	0.048 - 0.96 l/min depending on the nozzle diameter
Continuous operation:	Turbine < 500 rpm
Measuring accuracy:	+/- 2.0%
Repetition:	< +/- 0.25%
Temperature range:	-10°C bis +100°C 14°F bis 212°F
Pressure range:	20 bar at 20°C 290 psi /68°F
Mounting position:	Horizontal *
Nozzle size:	Ø 1.0, 1.2, 2.0, 2.5, 3.3 mm

Electrical connection ratings:

Power supply:	+ 3.8 to + 24 VDC
Consumption:	< 8 mA
Signal connection:	Open collector NPN
Signal voltage:	0 VDC GND (saturation < 0.7 V)
Signal load:	max. 20 mA
Leakage current:	max. 10 µA
Connections:	3Pin- AMP 2.8 x 0.8 mm
Signal:	Square-wave output
Duty Cycle:	~ 50%

Dimensions in mm:

* Horizontal position is, when the contacts facing up.

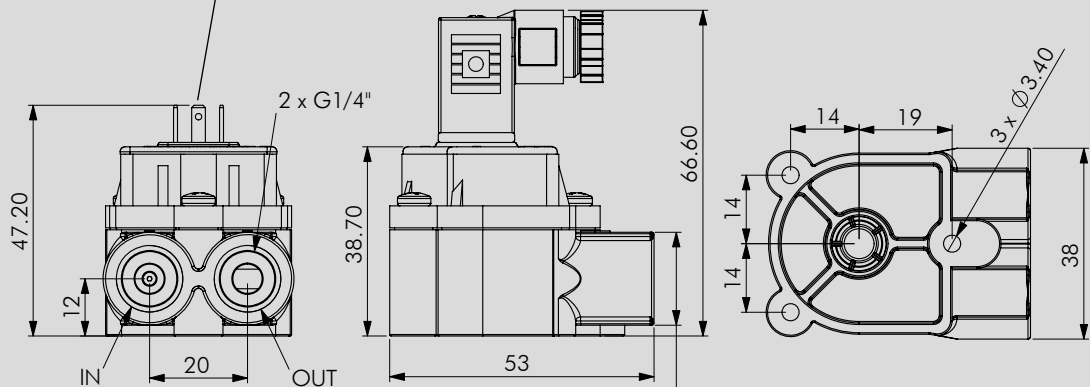

wrench size 19



Options: 3-pin valve connector
Item number: 941-0010/3

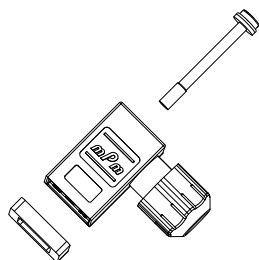

We reserve the right to make modifications in the interests of technical progress.

RESISTANCE

Special regulations which must be complied with by the flowmeter manufacturer apply to each country, e.g. CE, NSF, FDA and SK. The various media flowing through the flowmeter differ from application to application. You are advised to enquire with the medium manufacturer as to whether the entire installation and the flowmeter are resistant to the medium itself (see Material)!

ELECTRONIC

DIGMESA electronic circuitry is always designed for operation with DIGMESA flowmeters. Please note the following if connecting to other electronic circuitry:

- The flowmeter does not supply an output voltage but switches the signal terminal to 0 V ground (actuated) or leaves it open (non-actuated)
- There must be a pull-up resistor between power supply + and signal depending on electronic circuitry!

Version 02 FHK PVDF Chemie SW19 937-13w/Co01x GB Page 2-13

Interface Connection: Examples Open Collector

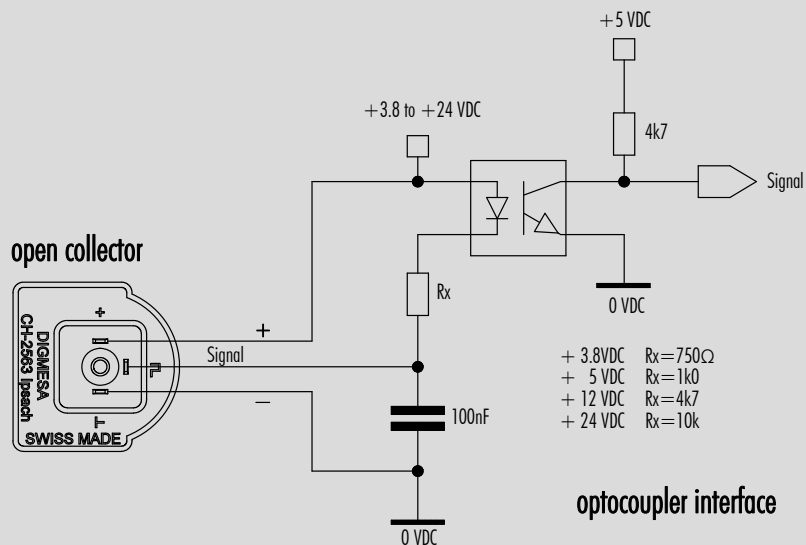
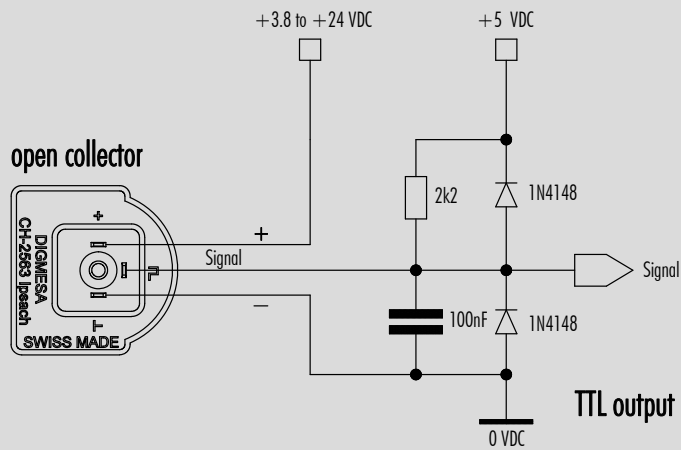
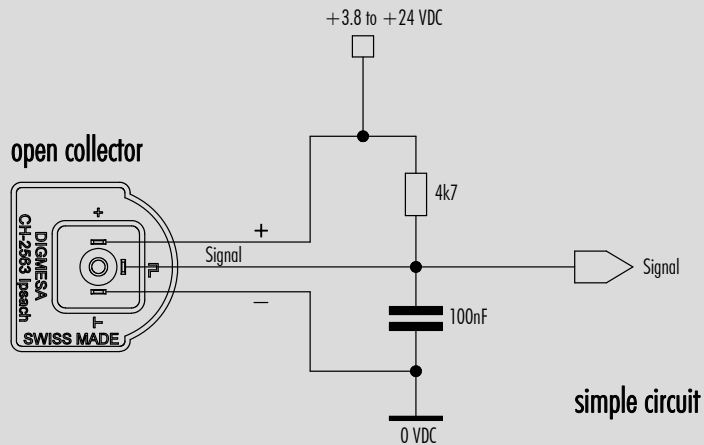

Measurement Curve FHK 1.00 mm (#937-1310/Cx012)

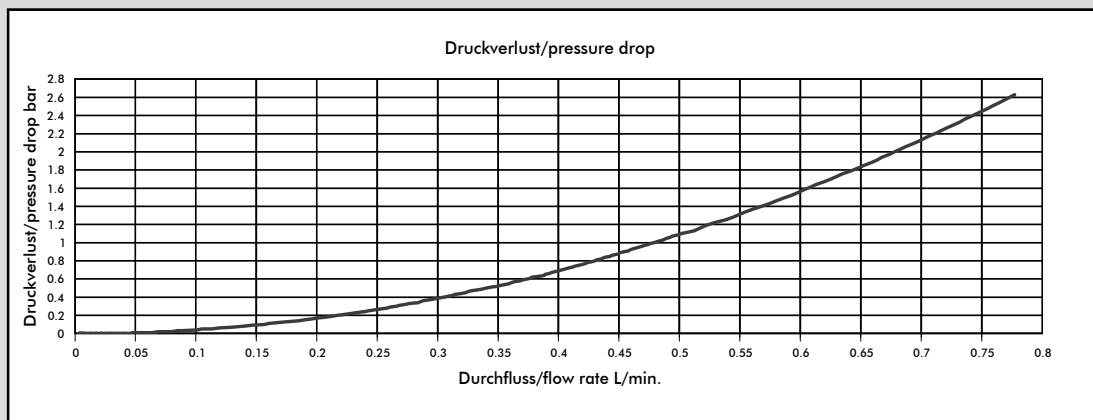
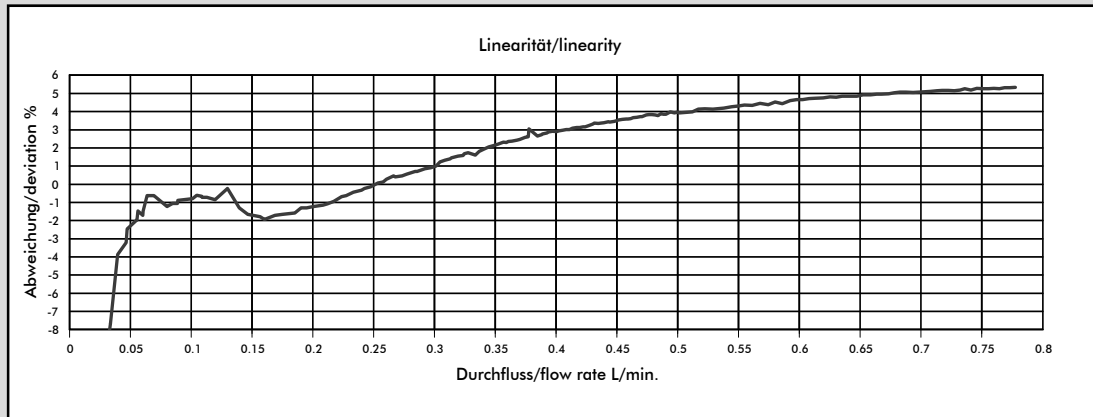

Medium: Water / max. Pressure: 3.3 bar

Nozzle size	Pulses/litre	Gramm/Puls	min. flow rate in [litres/min] at linear start	Flow rate at 500 rpm [l/min]
Ø 1.00 mm	2481	0.40	0.055	0.20
Ø 1.20 mm	1876	0.53	0.048	0.26
Ø 2.00 mm	1039	0.96	0.108	0.48
Ø 2.50 mm	721	1.38	0.074	0.69
Ø 3.30 mm	516	1.93	0.257	0.96

The values specified must be considered as approximate values.

The number of pulses per litre may differ depending on medium and installation.

We recommend to calibrate the number of pulses per litre in line with the complete installation.

MEASUREMENT TIPS

- Ensure that there is no fast-pulsatory movement of the media
- Ensure that there are no reverse pressure surges
- Ensure that there is no air in the system
- Keep the pressure loss as small as possible
- Note the mounting position of the flowmeter
- Min/max flow should be in the linear range of the selected flowmeter
- Clean the system at appropriate intervals
- Avoid electrical current peaks
- Incorrect cabling of power supply +, signal and ground will destroy the flowmeter
- Do not mechanically load electrical contacts
- Avoid moisture on the electrical contacts
- Avoid stray pick-up via the cable (Do not lay cables in parallel with high current loads)

Measurement Curve FHK 1.00 mm (#937-1310/Cx014)

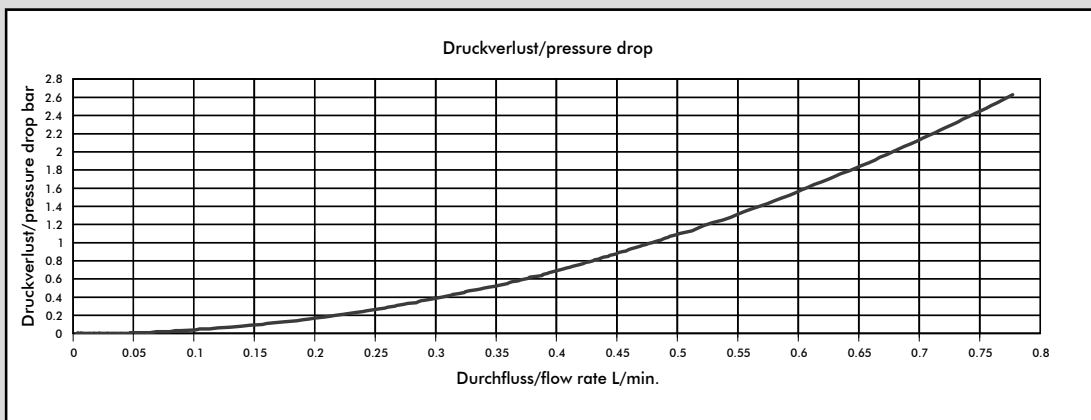
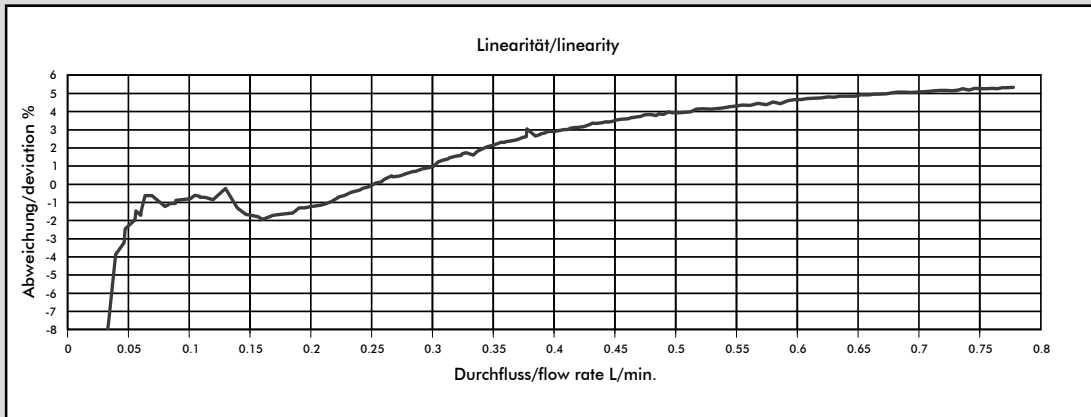

Medium: Water / max. Pressure: 3.3 bar

Nozzle size	Pulses/litre	Gramm/Puls	min. flow rate in [litres/min] at linear start	Flow rate at 500 rpm [l/min]
Ø 1.00 mm	4962	0.20	0.055	0.20
Ø 1.20 mm	3752	0.26	0.048	0.26
Ø 2.00 mm	2078	0.48	0.108	0.48
Ø 2.50 mm	1442	0.69	0.074	0.69
Ø 3.30 mm	1032	0.96	0.257	0.96

The values specified must be considered as approximate values.

The number of pulses per litre may differ depending on medium and installation.

We recommend to calibrate the number of pulses per litre in line with the complete installation.

MEASUREMENT TIPS

- Ensure that there is no fast-pulsatory movement of the media
- Ensure that there are no reverse pressure surges
- Ensure that there is no air in the system
- Keep the pressure loss as small as possible
- Note the mounting position of the flowmeter
- Min/max flow should be in the linear range of the selected flowmeter
- Clean the system at appropriate intervals
- Avoid electrical current peaks
- Incorrect cabling of power supply +, signal and ground will destroy the flowmeter
- Do not mechanically load electrical contacts
- Avoid moisture on the electrical contacts
- Avoid stray pick-up via the cable (Do not lay cables in parallel with high current loads)

Measurement Curve FHK 1.20 mm (#937-1312/Cx012)

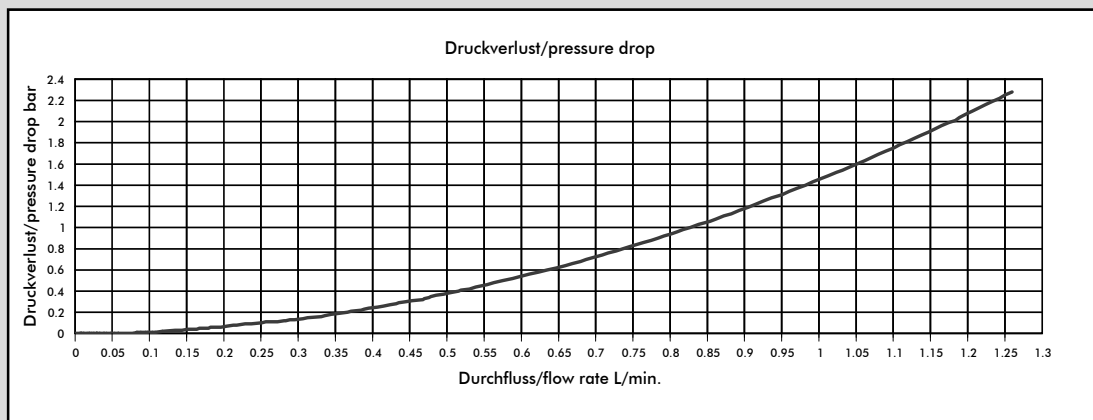
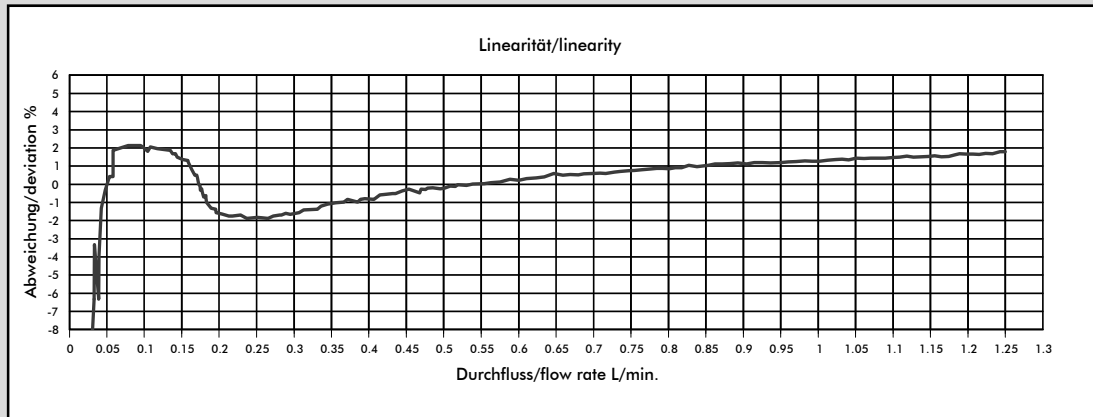

Medium: Water / max. Pressure: 3.3 bar

Nozzle size	Pulses/litre	Gramm/Puls	min. flow rate in [litres/min] at linear start	Flow rate at 500 rpm [l/min]
Ø 1.00 mm	2481	0.40	0.055	0.20
Ø 1.20 mm	1876	0.53	0.048	0.26
Ø 2.00 mm	1039	0.96	0.108	0.48
Ø 2.50 mm	721	1.38	0.074	0.69
Ø 3.30 mm	516	1.93	0.257	0.96

The values specified must be considered as approximate values.

The number of pulses per litre may differ depending on medium and installation.

We recommend to calibrate the number of pulses per litre in line with the complete installation.

MEASUREMENT TIPS

- Ensure that there is no fast-pulsatory movement of the media
- Ensure that there are no reverse pressure surges
- Ensure that there is no air in the system
- Keep the pressure loss as small as possible
- Note the mounting position of the flowmeter
- Min/max flow should be in the linear range of the selected flowmeter
- Clean the system at appropriate intervals
- Avoid electrical current peaks
- Incorrect cabling of power supply +, signal and ground will destroy the flowmeter
- Do not mechanically load electrical contacts
- Avoid moisture on the electrical contacts
- Avoid stray pick-up via the cable (Do not lay cables in parallel with high current loads)

Measurement Curve FHK 1.20 mm (#937-1312/Cx014)

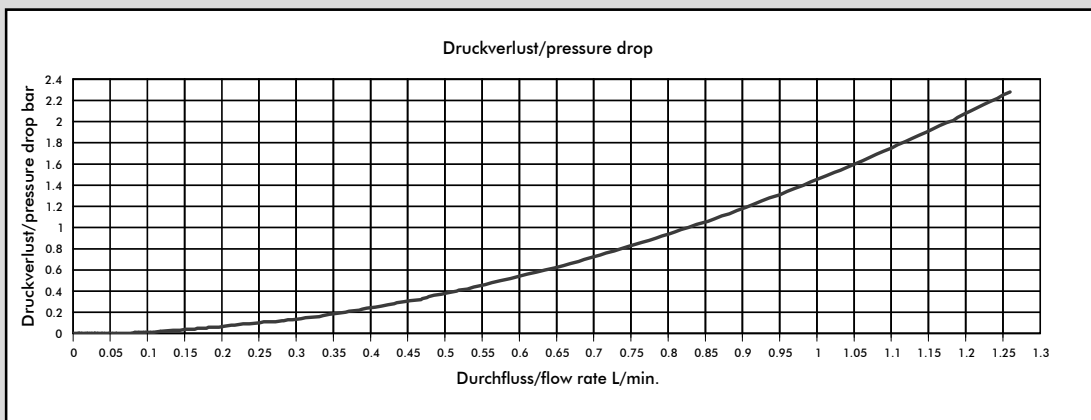
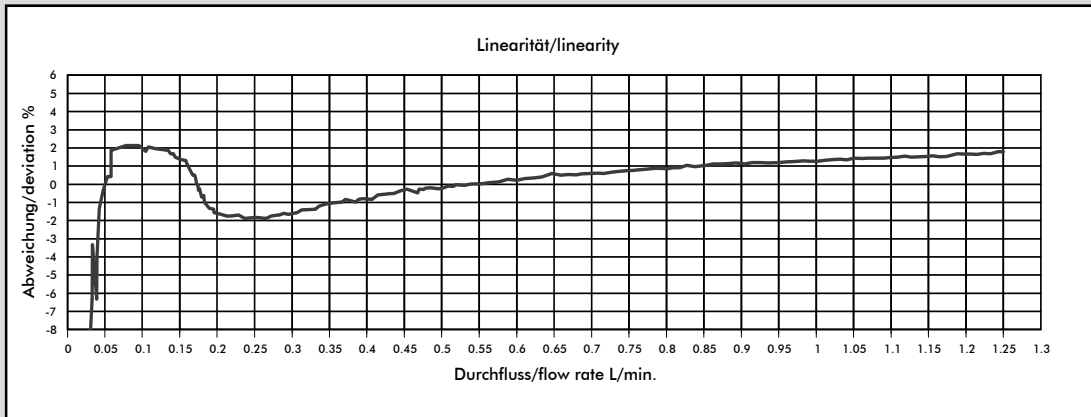

Medium: Water / max. Pressure: 3.3 bar

Nozzle size	Pulses/litre	Gramm/Puls	min. flow rate in [litres/min] at linear start	Flow rate at 500 rpm [l/min]
Ø 1.00 mm	4962	0.20	0.055	0.20
Ø 1.20 mm	3752	0.26	0.048	0.26
Ø 2.00 mm	2078	0.48	0.108	0.48
Ø 2.50 mm	1442	0.69	0.074	0.69
Ø 3.30 mm	1032	0.96	0.257	0.96

The values specified must be considered as approximate values.

The number of pulses per litre may differ depending on medium and installation.

We recommend to calibrate the number of pulses per litre in line with the complete installation.

MEASUREMENT TIPS

- Ensure that there is no fast-pulsatory movement of the media
- Ensure that there are no reverse pressure surges
- Ensure that there is no air in the system
- Keep the pressure loss as small as possible
- Note the mounting position of the flowmeter
- Min/max flow should be in the linear range of the selected flowmeter
- Clean the system at appropriate intervals
- Avoid electrical current peaks
- Incorrect cabling of power supply +, signal and ground will destroy the flowmeter
- Do not mechanically load electrical contacts
- Avoid moisture on the electrical contacts
- Avoid stray pick-up via the cable (Do not lay cables in parallel with high current loads)

Measurement Curve FHK 2.00 mm (#937-1320/Cx012)

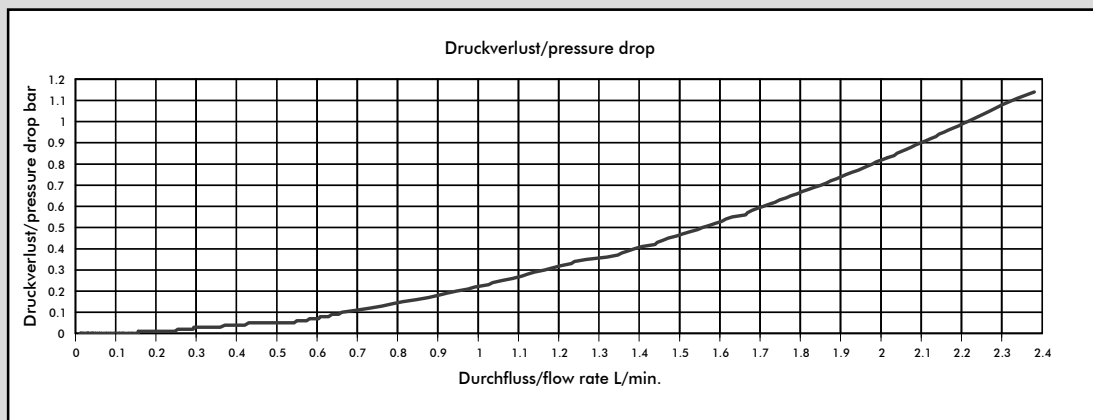
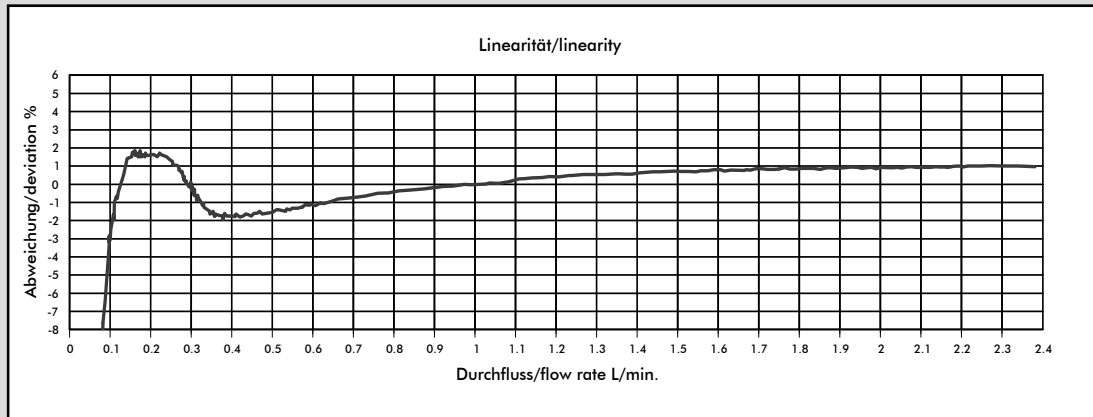

Medium: Water / max. Pressure: 3.3 bar

Nozzle size	Pulses/litre	Gramm/Puls	min. flow rate in [litres/min] at linear start	Flow rate at 500 rpm [l/min]
Ø 1.00 mm	2481	0.40	0.055	0.20
Ø 1.20 mm	1876	0.53	0.048	0.26
Ø 2.00 mm	1039	0.96	0.108	0.48
Ø 2.50 mm	721	1.38	0.074	0.69
Ø 3.30 mm	516	1.93	0.257	0.96

The values specified must be considered as approximate values.

The number of pulses per litre may differ depending on medium and installation.

We recommend to calibrate the number of pulses per litre in line with the complete installation.

MEASUREMENT TIPS

- Ensure that there is no fast-pulsatory movement of the media
- Ensure that there are no reverse pressure surges
- Ensure that there is no air in the system
- Keep the pressure loss as small as possible
- Note the mounting position of the flowmeter
- Min/max flow should be in the linear range of the selected flowmeter
- Clean the system at appropriate intervals
- Avoid electrical current peaks
- Incorrect cabling of power supply +, signal and ground will destroy the flowmeter
- Do not mechanically load electrical contacts
- Avoid moisture on the electrical contacts
- Avoid stray pick-up via the cable (Do not lay cables in parallel with high current loads)

Measurement Curve FHK 2.00 mm (#937-1320/Cx014)

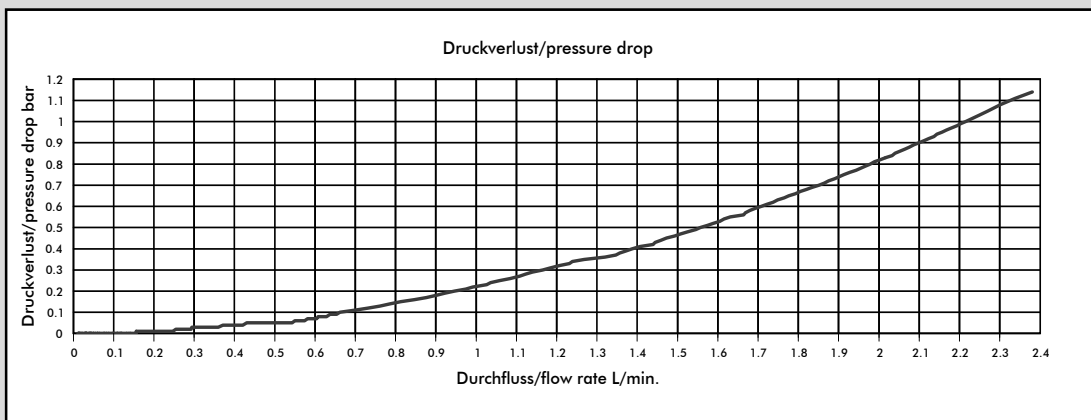
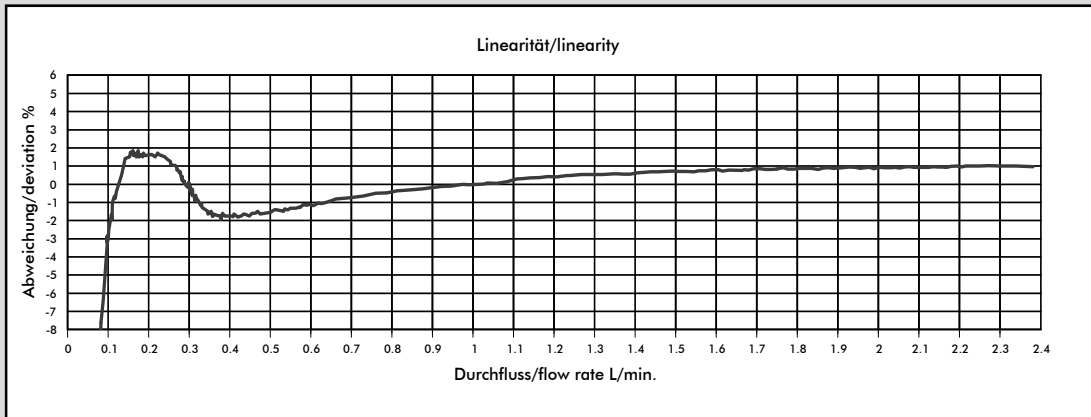

Medium: Water / max. Pressure: 3.3 bar

Nozzle size	Pulses/litre	Gramm/Puls	min. flow rate in [litres/min] at linear start	Flow rate at 500 rpm [l/min]
Ø 1.00 mm	4962	0.20	0.055	0.20
Ø 1.20 mm	3752	0.26	0.048	0.26
Ø 2.00 mm	2078	0.48	0.108	0.48
Ø 2.50 mm	1442	0.69	0.074	0.69
Ø 3.30 mm	1032	0.96	0.257	0.96

The values specified must be considered as approximate values.

The number of pulses per litre may differ depending on medium and installation.

We recommend to calibrate the number of pulses per litre in line with the complete installation.

MEASUREMENT TIPS

- Ensure that there is no fast-pulsatory movement of the media
- Ensure that there are no reverse pressure surges
- Ensure that there is no air in the system
- Keep the pressure loss as small as possible
- Note the mounting position of the flowmeter
- Min/max flow should be in the linear range of the selected flowmeter
- Clean the system at appropriate intervals
- Avoid electrical current peaks
- Incorrect cabling of power supply +, signal and ground will destroy the flowmeter
- Do not mechanically load electrical contacts
- Avoid moisture on the electrical contacts
- Avoid stray pick-up via the cable (Do not lay cables in parallel with high current loads)

Measurement Curve FHK 2.50 mm (#937-1325/Cx012)

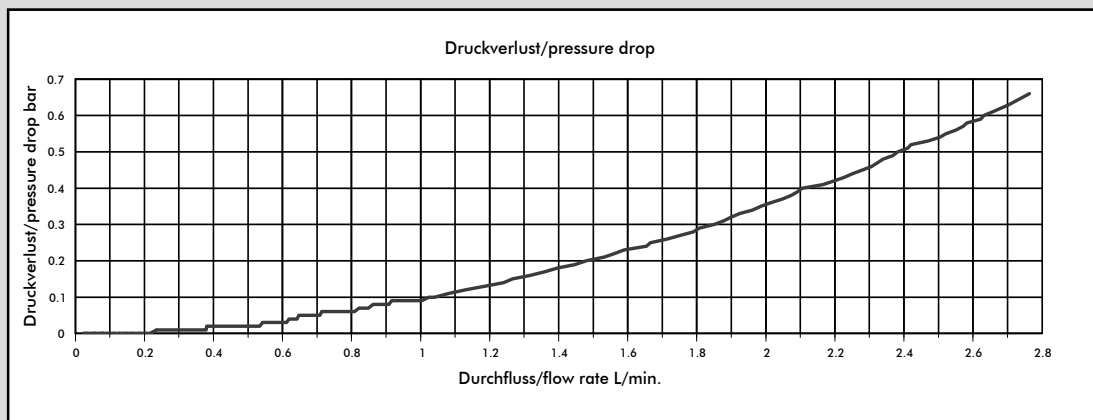
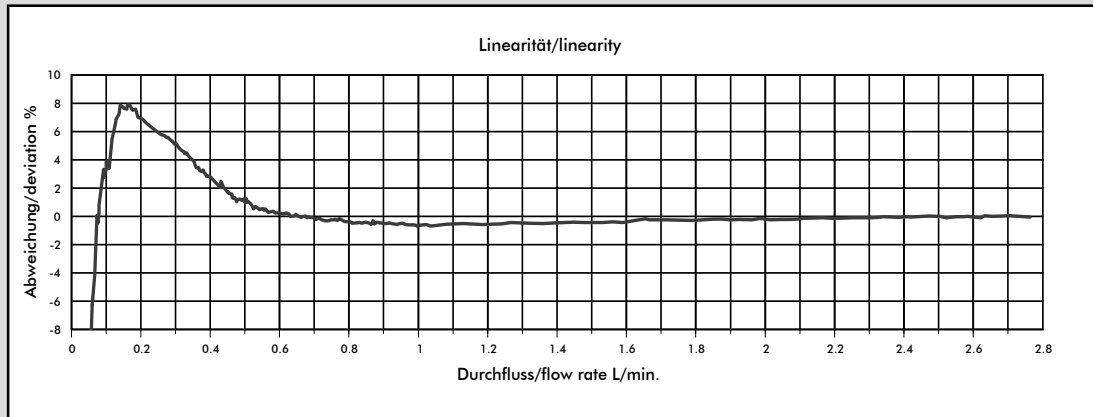

Medium: Water / max. Pressure: 3.3 bar

Nozzle size	Pulses/litre	Gramm/Puls	min. flow rate in [litres/min] at linear start	Flow rate at 500 rpm [l/min]
Ø 1.00 mm	2481	0.40	0.055	0.20
Ø 1.20 mm	1876	0.53	0.048	0.26
Ø 2.00 mm	1039	0.96	0.108	0.48
Ø 2.50 mm	721	1.38	0.074	0.69
Ø 3.30 mm	516	1.93	0.257	0.96

The values specified must be considered as approximate values.

The number of pulses per litre may differ depending on medium and installation.

We recommend to calibrate the number of pulses per litre in line with the complete installation.

MEASUREMENT TIPS

- Ensure that there is no fast-pulsatory movement of the media
- Ensure that there are no reverse pressure surges
- Ensure that there is no air in the system
- Keep the pressure loss as small as possible
- Note the mounting position of the flowmeter
- Min/max flow should be in the linear range of the selected flowmeter
- Clean the system at appropriate intervals
- Avoid electrical current peaks
- Incorrect cabling of power supply +, signal and ground will destroy the flowmeter
- Do not mechanically load electrical contacts
- Avoid moisture on the electrical contacts
- Avoid stray pick-up via the cable (Do not lay cables in parallel with high current loads)

Measurement Curve FHK 2.50 mm (#937-1325/Cx014)

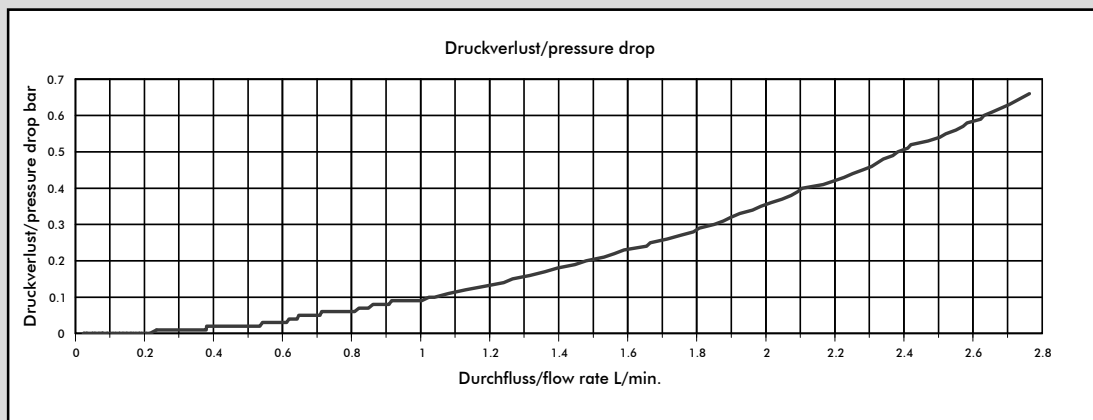
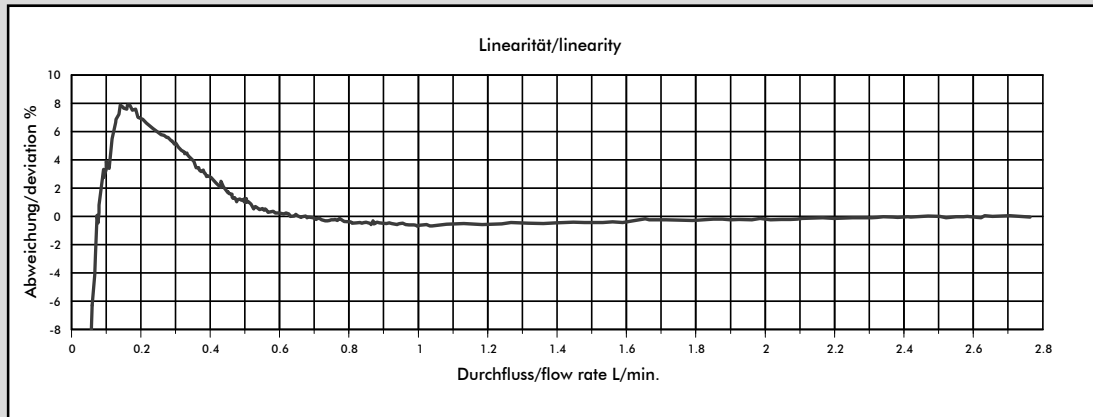

Medium: Water / max. Pressure: 3.3 bar

Nozzle size	Pulses/litre	Gramm/Puls	min. flow rate in [litres/min] at linear start	Flow rate at 500 rpm [l/min]
Ø 1.00 mm	4962	0.20	0.055	0.20
Ø 1.20 mm	3752	0.26	0.048	0.26
Ø 2.00 mm	2078	0.48	0.108	0.48
Ø 2.50 mm	1442	0.69	0.074	0.69
Ø 3.30 mm	1032	0.96	0.257	0.96

The values specified must be considered as approximate values.

The number of pulses per litre may differ depending on medium and installation.

We recommend to calibrate the number of pulses per litre in line with the complete installation.

MEASUREMENT TIPS

- Ensure that there is no fast-pulsatory movement of the media
- Ensure that there are no reverse pressure surges
- Ensure that there is no air in the system
- Keep the pressure loss as small as possible
- Note the mounting position of the flowmeter
- Min/max flow should be in the linear range of the selected flowmeter
- Clean the system at appropriate intervals
- Avoid electrical current peaks
- Incorrect cabling of power supply +, signal and ground will destroy the flowmeter
- Do not mechanically load electrical contacts
- Avoid moisture on the electrical contacts
- Avoid stray pick-up via the cable (Do not lay cables in parallel with high current loads)

Measurement Curve FHK Ø3.30mm (#937-1333/Cx012)

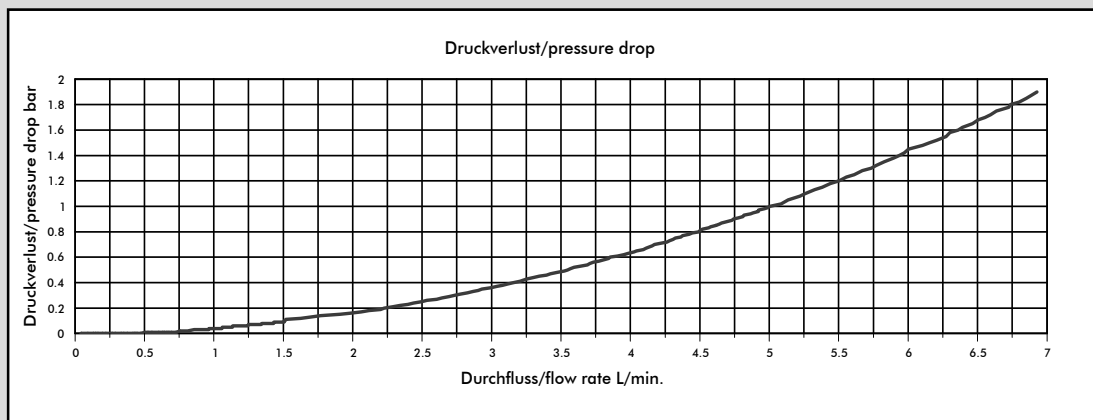
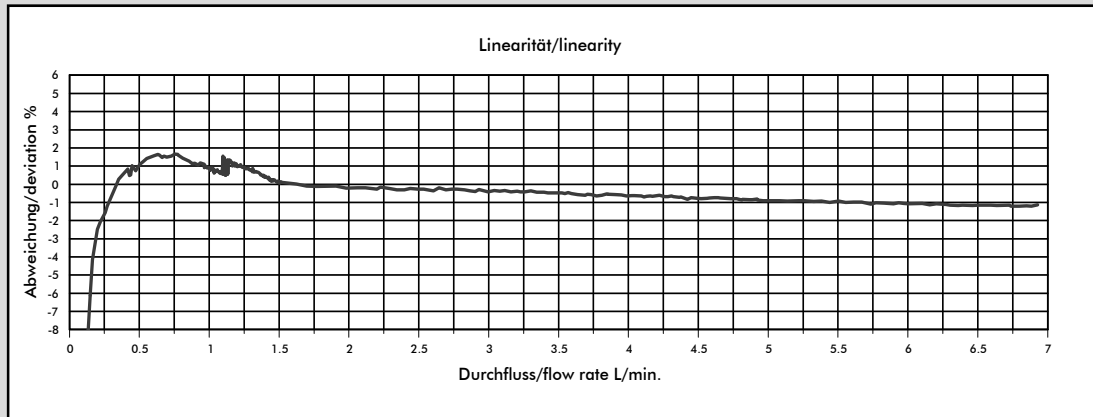

Medium: Water / max. Pressure: 3.3 bar

Nozzle size	Pulses/litre	Gramm/Puls	min. flow rate in [litres/min] at linear start	Flow rate at 500 rpm [l/min]
Ø 1.00 mm	2481	0.40	0.055	0.20
Ø 1.20 mm	1876	0.53	0.048	0.26
Ø 2.00 mm	1039	0.96	0.108	0.48
Ø 2.50 mm	721	1.38	0.074	0.69
Ø 3.30 mm	516	1.93	0.257	0.96

The values specified must be considered as approximate values.

The number of pulses per litre may differ depending on medium and installation.

We recommend to calibrate the number of pulses per litre in line with the complete installation.

MEASUREMENT TIPS

- Ensure that there is no fast-pulsatory movement of the media
- Ensure that there are no reverse pressure surges
- Ensure that there is no air in the system
- Keep the pressure loss as small as possible
- Note the mounting position of the flowmeter
- Min/max flow should be in the linear range of the selected flowmeter
- Clean the system at appropriate intervals
- Avoid electrical current peaks
- Incorrect cabling of power supply +, signal and ground will destroy the flowmeter
- Do not mechanically load electrical contacts
- Avoid moisture on the electrical contacts
- Avoid stray pick-up via the cable (Do not lay cables in parallel with high current loads)

Measurement Curve FHK Ø3.30mm (#937-1333/Cx014)

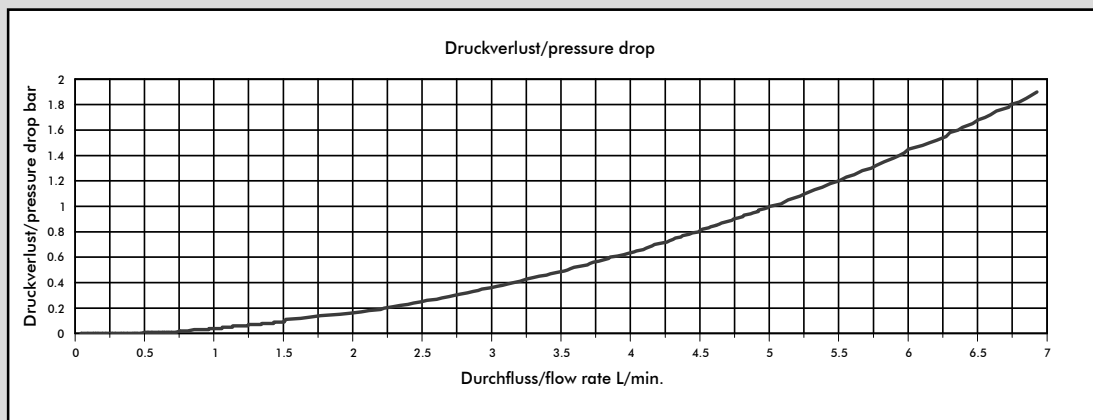
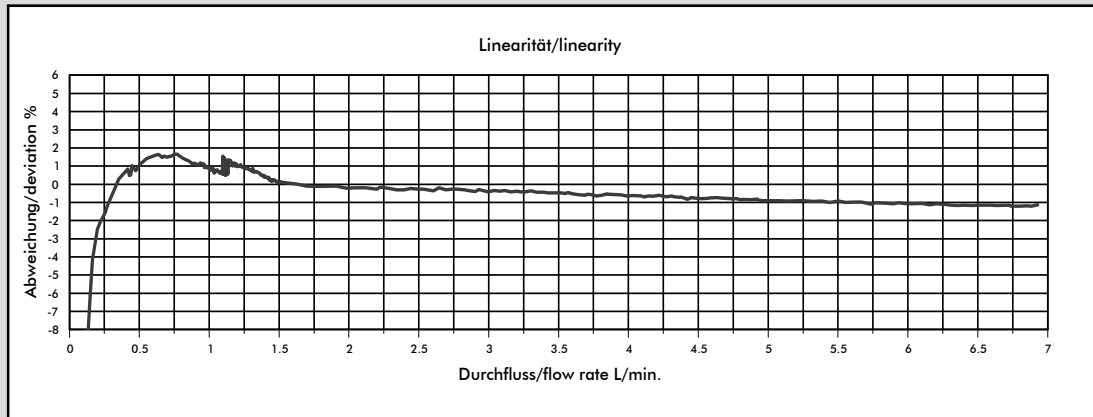

Medium: Water / max. Pressure: 3.3 bar

Nozzle size	Pulses/litre	Gramm/Puls	min. flow rate in [litres/min] at linear start	Flow rate at 500 rpm [l/min]
Ø 1.00 mm	4962	0.20	0.055	0.20
Ø 1.20 mm	3752	0.26	0.048	0.26
Ø 2.00 mm	2078	0.48	0.108	0.48
Ø 2.50 mm	1442	0.69	0.074	0.69
Ø 3.30 mm	1032	0.96	0.257	0.96

The values specified must be considered as approximate values.

The number of pulses per litre may differ depending on medium and installation.

We recommend to calibrate the number of pulses per litre in line with the complete installation.

MEASUREMENT TIPS

- Ensure that there is no fast-pulsatory movement of the media
- Ensure that there are no reverse pressure surges
- Ensure that there is no air in the system
- Keep the pressure loss as small as possible
- Note the mounting position of the flowmeter
- Min/max flow should be in the linear range of the selected flowmeter
- Clean the system at appropriate intervals
- Avoid electrical current peaks
- Incorrect cabling of power supply +, signal and ground will destroy the flowmeter
- Do not mechanically load electrical contacts
- Avoid moisture on the electrical contacts
- Avoid stray pick-up via the cable (Do not lay cables in parallel with high current loads)